

5055 INVISIBLE Hinges used to
HINGE TOP

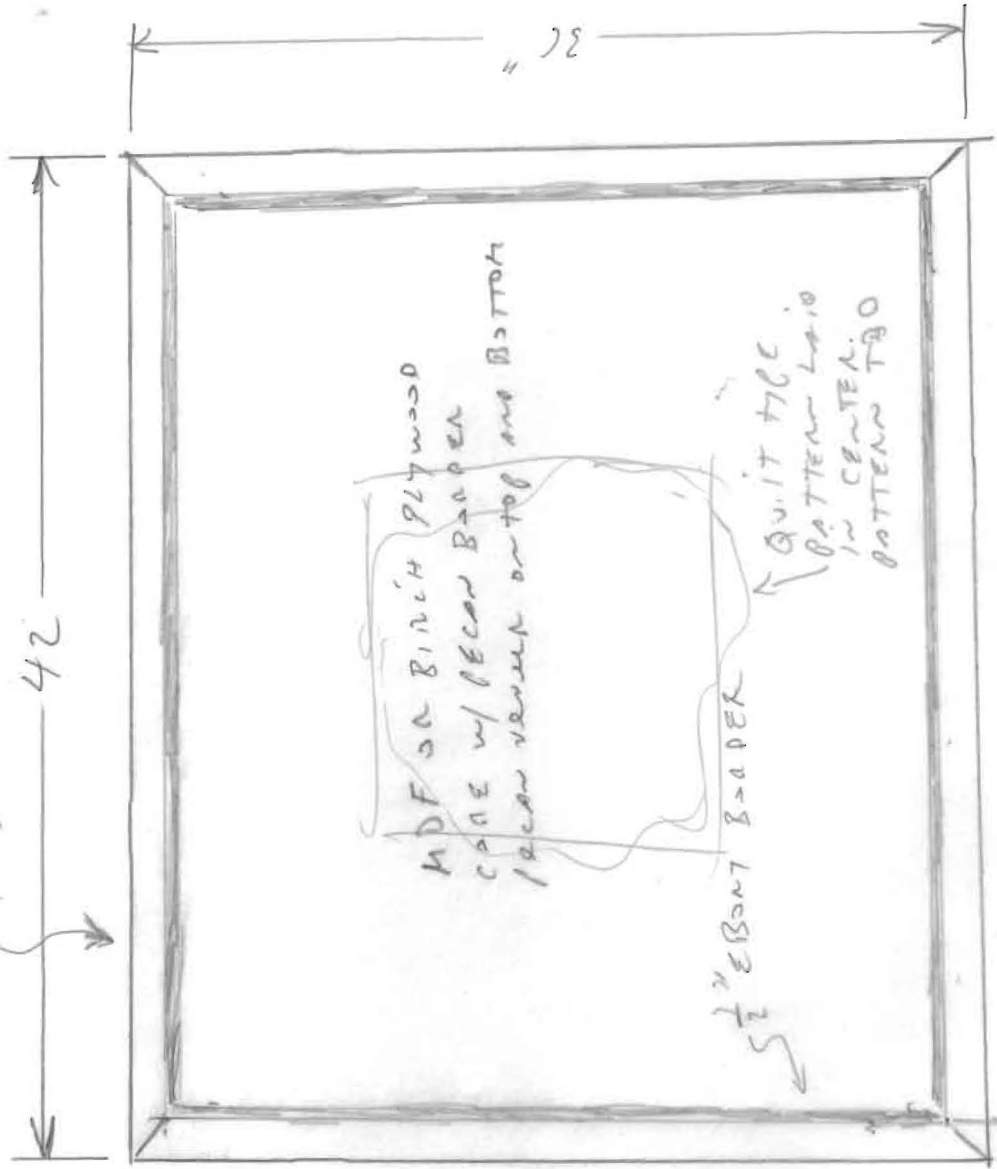

1/2"

EXPANDING KITCHEN TABLE
DRAWN BY: P.M. HENDERSON

TOP VIEW - TABLE CLOSED

SCALE 1/4" = 1"

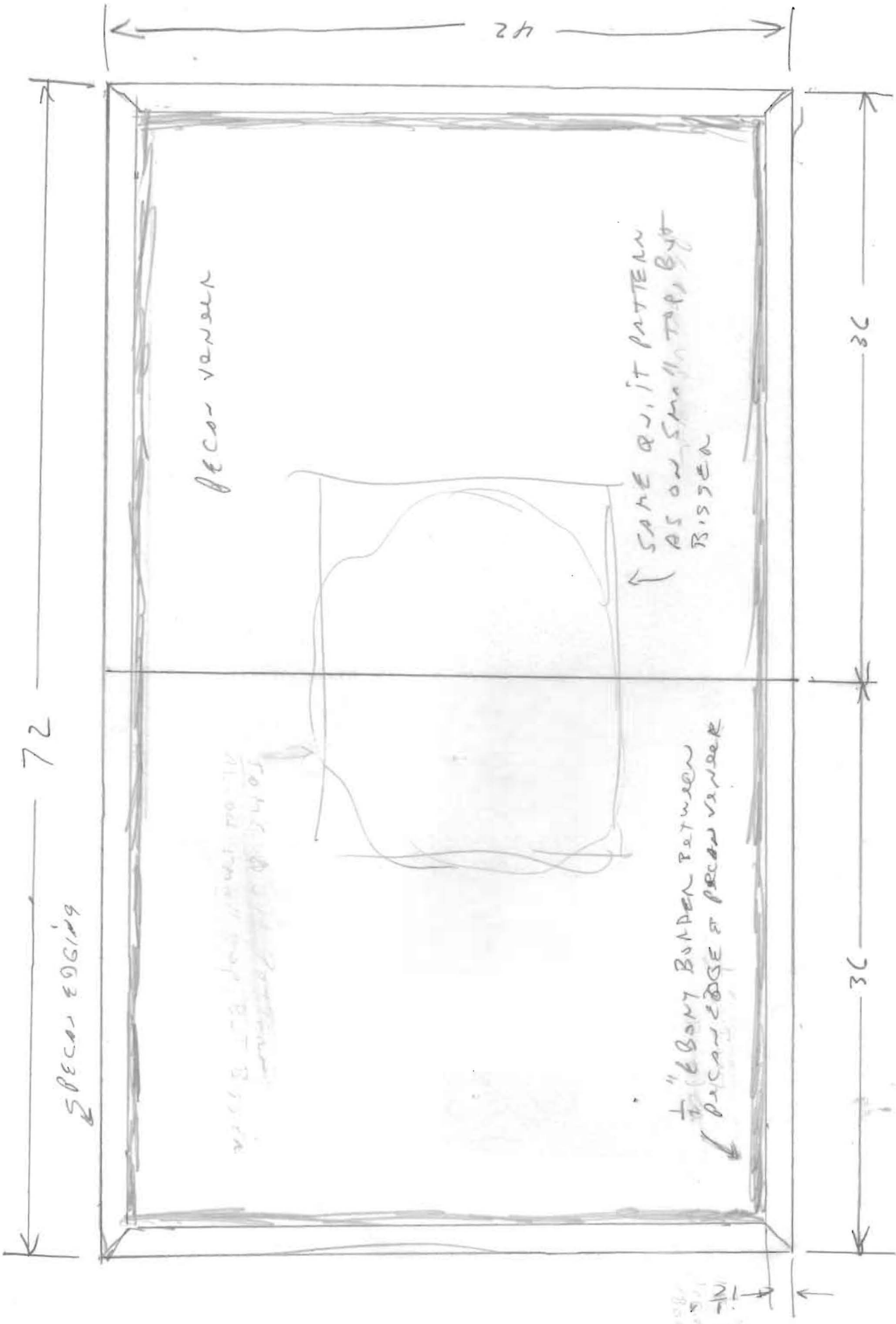

TOP VIEW - TOP EDGE OPEN
 ROTATED 90° FROM OTHER TOP VIEW

P.M. HENDERSON
 Scale 1/8" = 1"

Sheet 2 of 5

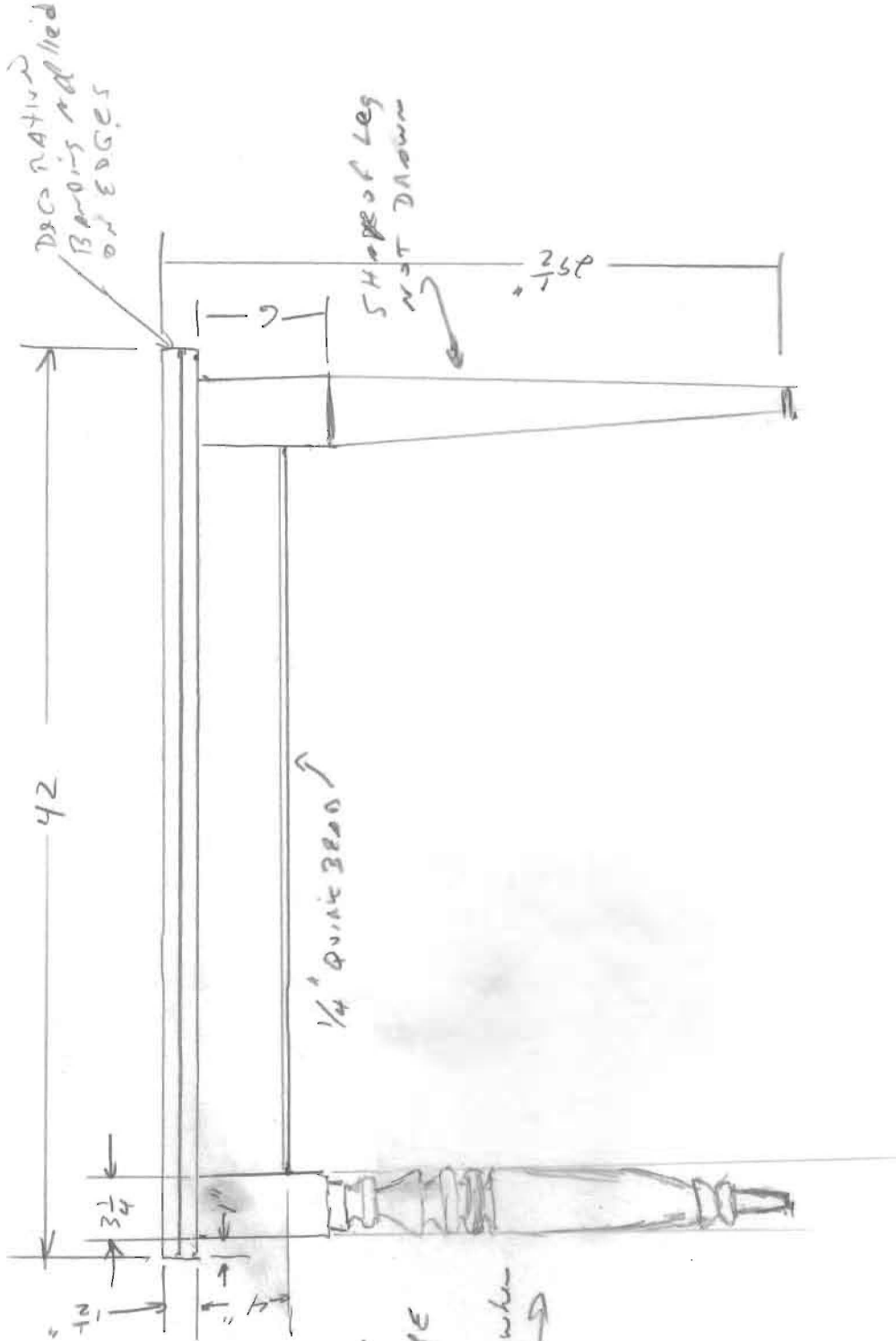

DECORATIVE
BANDING APPLIED
ON EDGES

SHAPE OF LEG
NOT DRAWN

$\frac{2}{1} 68$

42

$\frac{1}{4}$ " QUILL BEAD

$\frac{3}{4}$ "

$\frac{1}{2}$ "

$\frac{1}{4}$ "

MODEL ONLY -
FINAL SHAPE
OF LEGS
DETERMINED WHEN
TURNING

FRONT VIEW - TOP FOLDED

P. M. HEN DENSON
SCALE $\frac{1}{8} = 1"$

top attachment

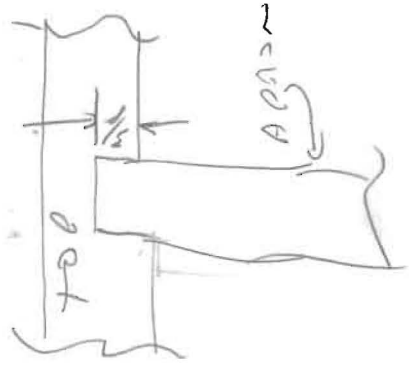

P.M. HENDERSON
scale 1/4" = 1"

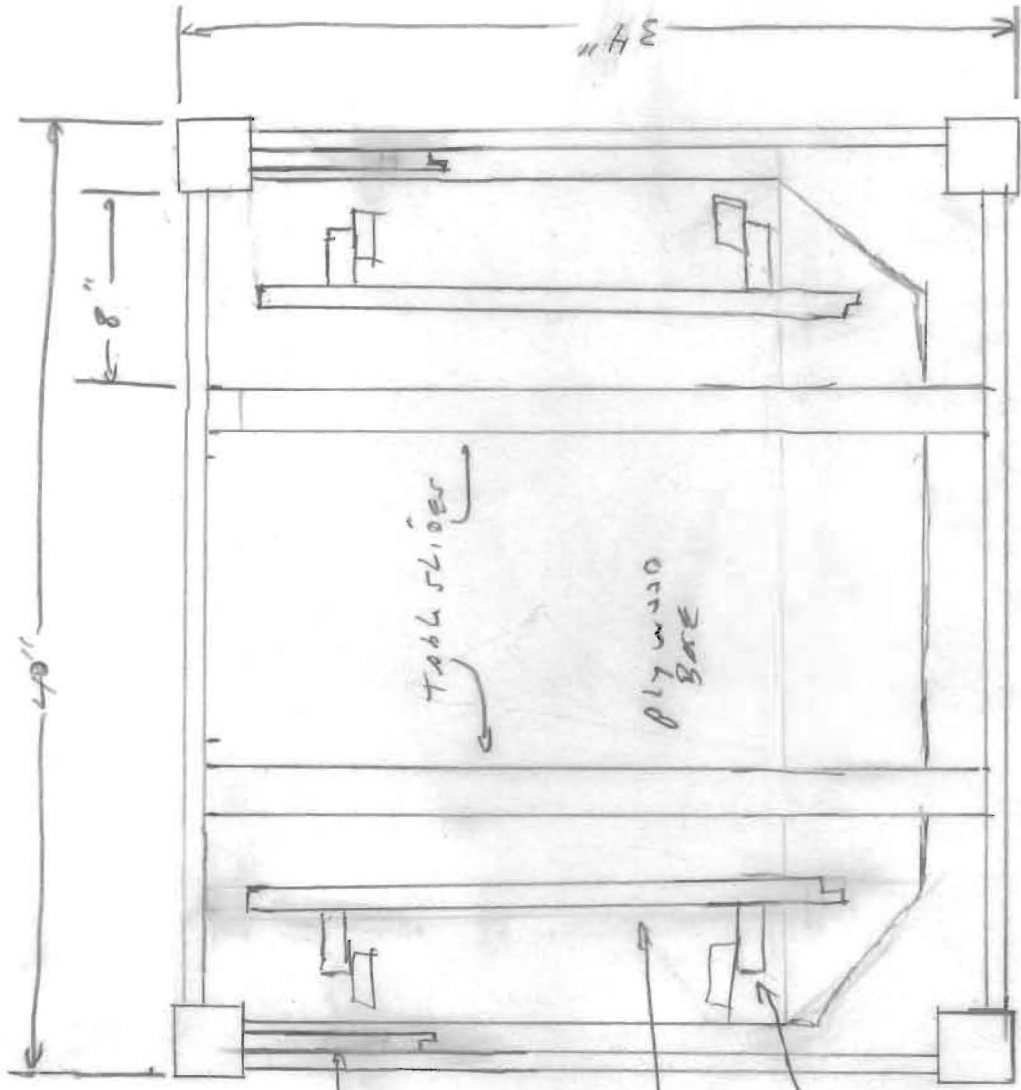

swinging
START

Pivoting
START

Pivot
Block

TOP view - table closed, TOP REMOVED

Sheet 4 of 5

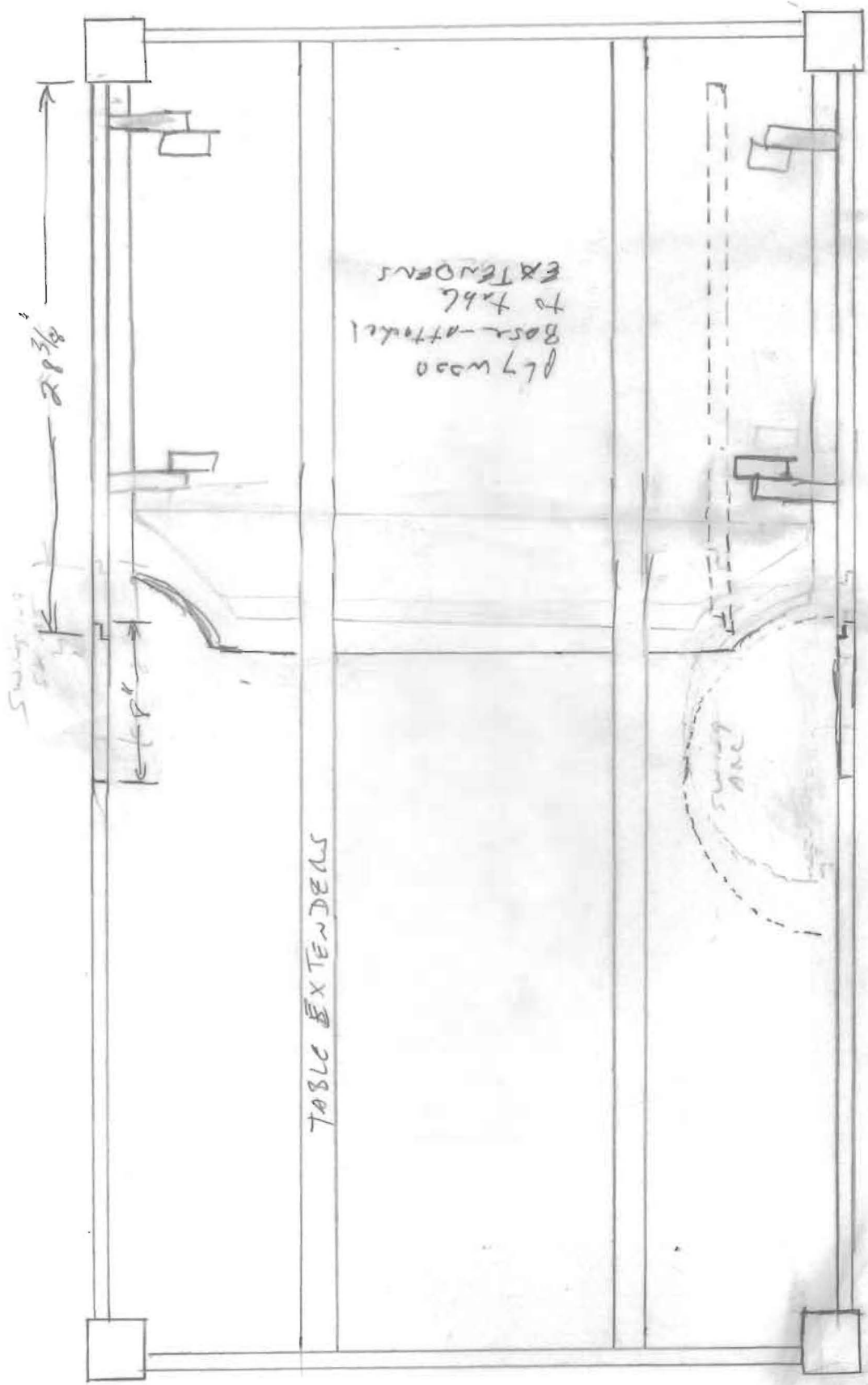

top view - table open, top removed

P.M. HENDERSON
SCALE 1/8" = 1"

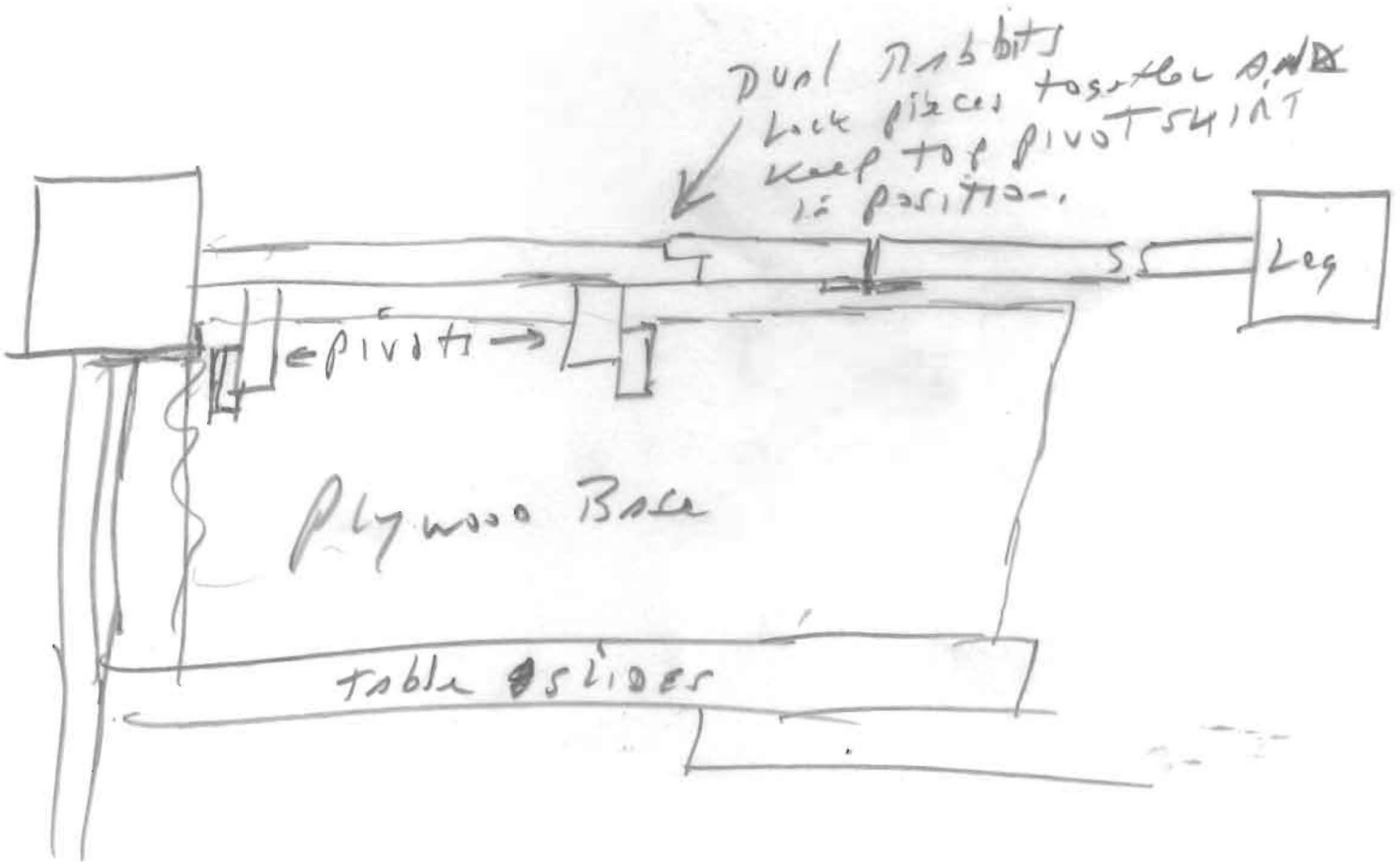
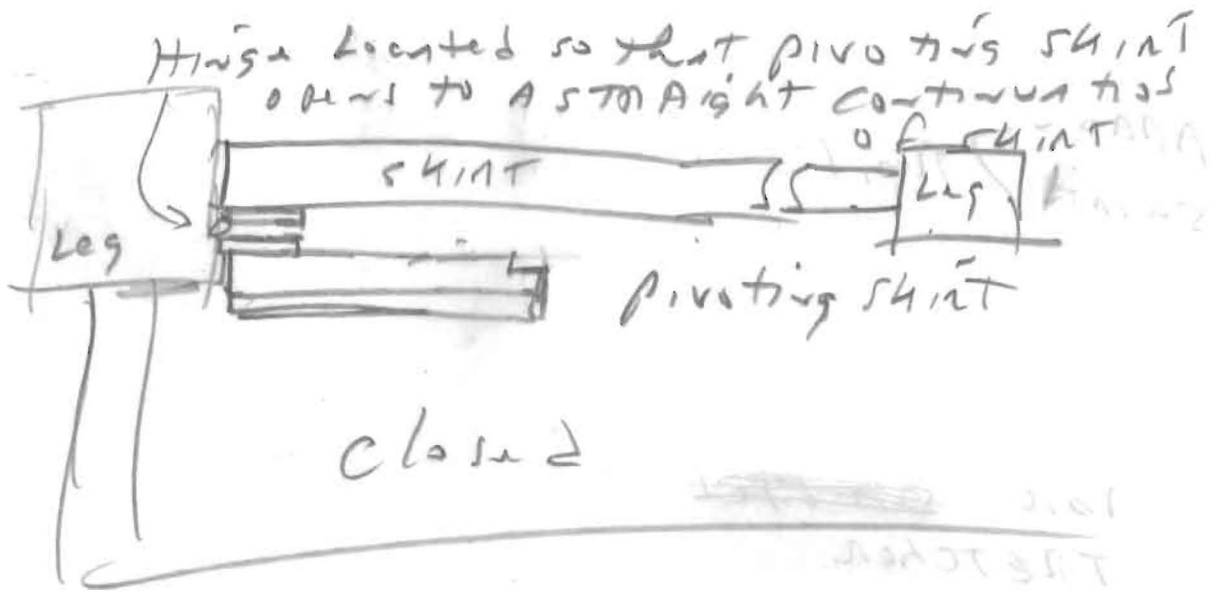

Movable Skirt
Details

UP position

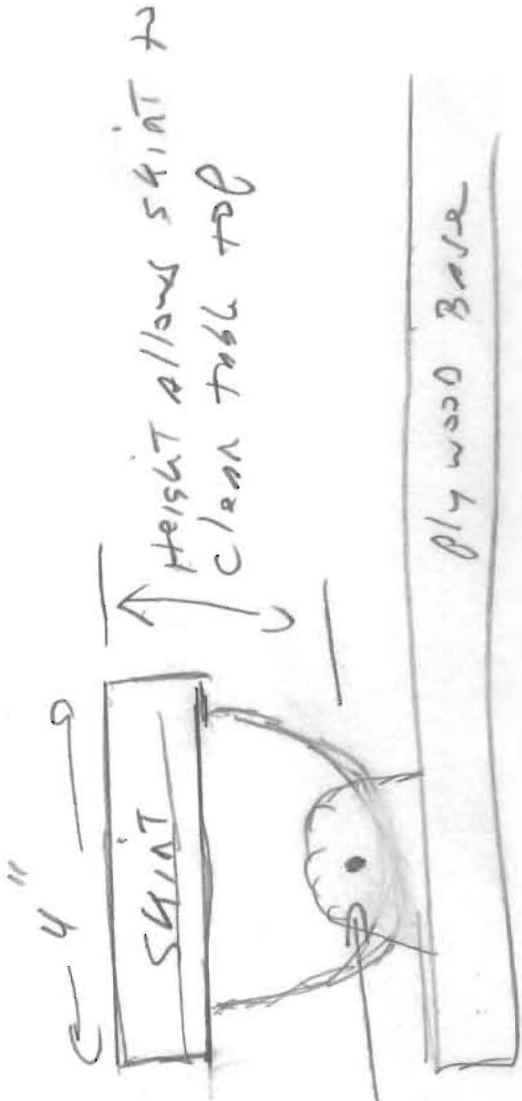

PIVOT
Point
~~offset 4~~
~~left 20~~
~~has mechanism~~
~~is sketched in~~
~~UP position~~
~~OR~~
skirt pivots till
it rests on plywood
Base

Down position

PIVOT rests on
plywood base to
RESISTER SKIRT.
CONCRETE IS PARTIAL



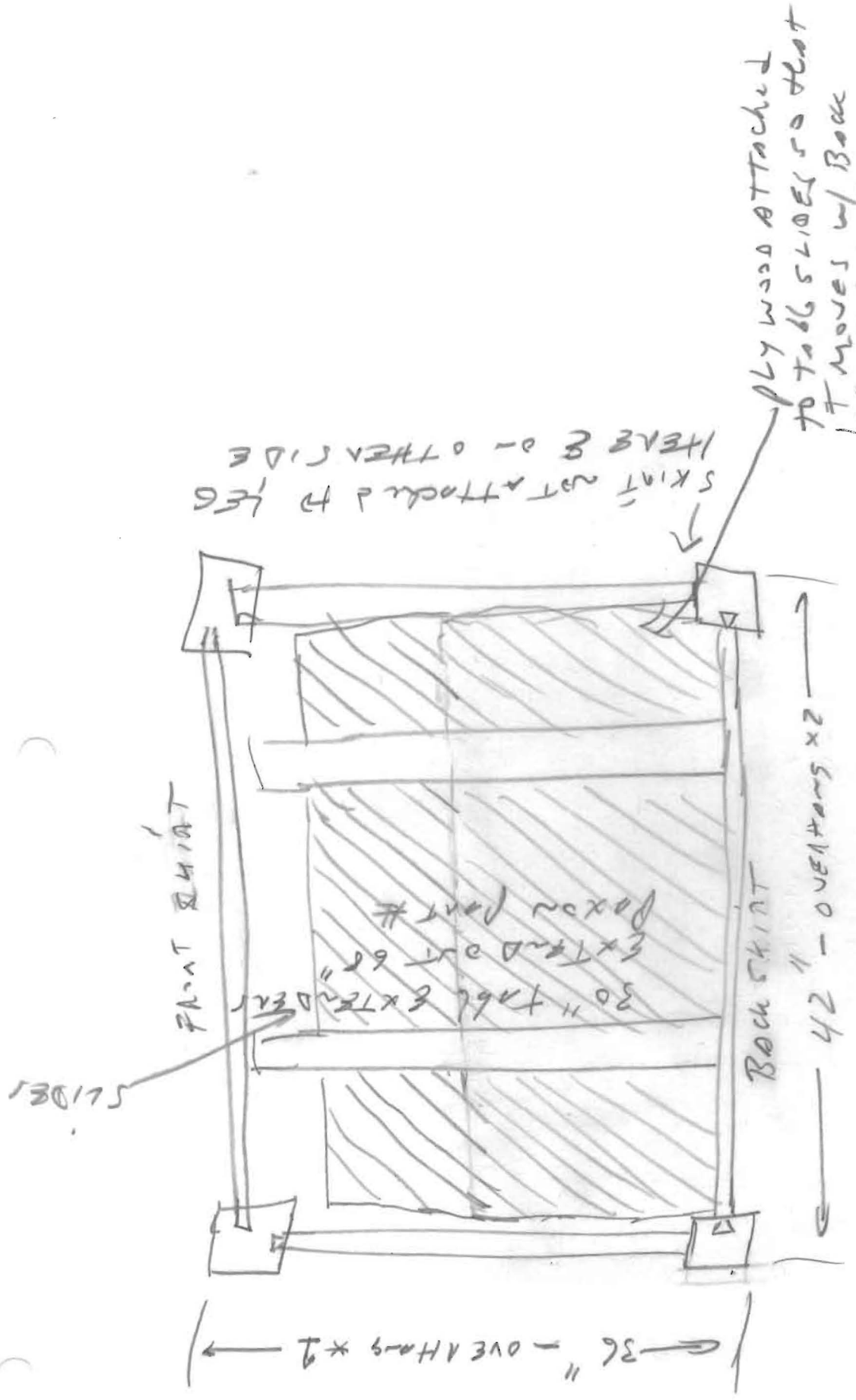

SKIRT NOT ATTACHED TO LEG
HERE IS ON OTHER SIDE

PLY WOOD ATTACHED
TO TABLE SLIDES SO THAT
IT MOVES W/ BACK
SKIRT & LEGS.

TABLE EXTENDER

BACK SKIRT & LEGS ATTACHED TO TABLE EXTENDER
W/ ANGLE IRON.
BACK SKIRT & LEGS PULL OUT TO SUPPORT FOLDING TOP

TOP IS VENEERED. PATTERN ON "FOLDED TOP"

HINTS of PATTERN on OPEN TOP.

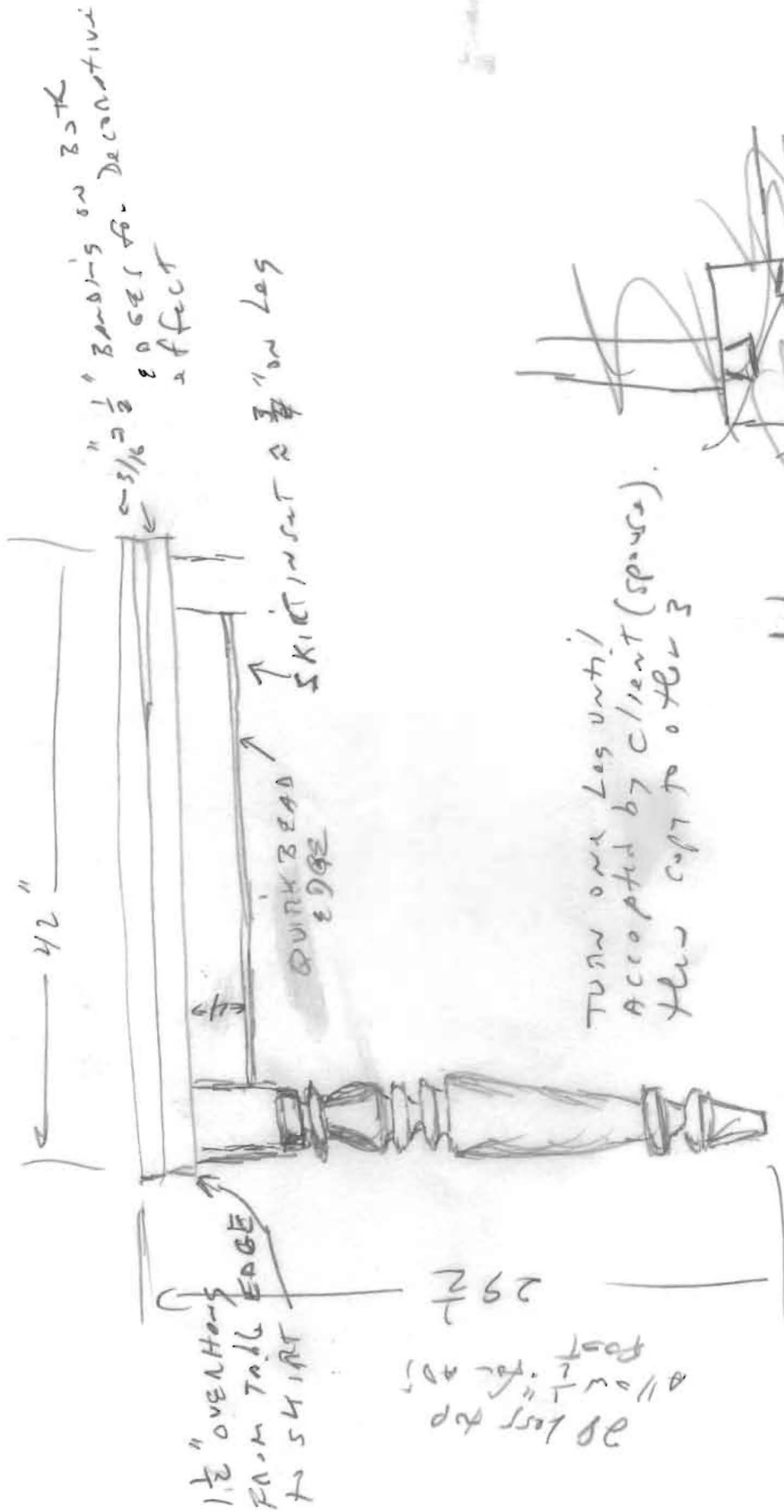

3/16" BANDS on BACK
EDGES for Decorative
effect

1 1/2" OVERHANG
FROM TAIL EDGE
TO SKIRT

QUICK BEAD
EDGE

SKIRT INSTANT 2 3/4" on LEG

29 1/2"
Allow 1" for ADJ
29 best top

TURN over Leg until!
ACCEPTED by CLIENT (SPONSOR).
then COPY TO OTHER 3

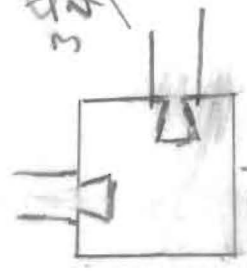

ALTERNATE 3/4
APPROX: 3/4
MORTISE
TENON

LEG TOP VIEW

